

GEMINI 1000/2000 - 6-DIGIT PRESETTABLE COUNTERS OR RATE INDICATORS GEMINI 1000 - SINGLE LEVEL & GEMINI 2000 - DUAL LEVEL w/OPTIONAL 20 mA CURRENT LOOP



- SEALED FRONT PANEL CONSTRUCTION (NEMA 4/IP65)
- NON-VOLATILE MEMORY (E²PROM)
- ABILITY TO LOCK OUT FRONT PANEL FUNCTIONS
- SIMPLIFIED FRONT PANEL FOR PROGRAMMING EASE
- 6-DIGIT, 0.56" (14.2 mm) HIGH LED DISPLAY WITH NEGATIVE SIGN & OVERFLOW INDICATORS
- FUNCTIONS AS COUNTER OR RATE INDICATOR
- INPUT SCALING FOR BUILT-IN RATE MULT./DIV.
- ACCEPTS INPUT COUNT RATES UP TO 10 KHZ
- BI-DIRECTIONAL COUNTING, UP/DOWN CONTROL
- QUADRATURE SENSING (Up to 4 times resolution)
- ANTI-COINCIDENCE ADDITION AND SUBTRACTION
- SEPARATE INPUT FOR MAGNETIC PICKUPS
- SOLID-STATE CURRENT SINK OUTPUT(S)
- OPTIONAL RELAY OUTPUTS (Field Replaceable)
- PROGRAMMABLE OUTPUT TIME DELAYS
- UP TO THREE RIGHT-HAND "DUMMY ZEROS"
- FULL PROGRAMMABILITY OF DECIMAL POINT LOCATION AND LEADING ZERO BLANKING

DESCRIPTION

The Gemini 1000 and 2000 offer the features and performance of a single/dual level preset counter or a programmable sample time rate indicator in one economically priced package. The reliability of solid-state MOS technology coupled with the flexibility of user programmable functions makes these units ideally suited to handle practically any preset control application.

As a counter, the Gemini 1000/2000 offers a choice of six (6) programmable counting modes to cover Bi-directional, Anti-Coincidence, and Quadrature applications. The input circuitry is switch selectable to accept signals from a wide variety of sources. In addition, the unit may be programmed to register counts on both edges of the input signal thus providing frequency doubling capability. The choice of several reset cycle modes along with the compatibility of count and control inputs to other RLC products, provides added versatility for both stand-alone and systems counter needs.

As a rate indicator, the Gemini 1000/2000 features crystal-controlled accuracy along with a variety of data sampling times to allow the needed resolution for precision applications. The combination of 5-digit scale factor and decade scale multipliers provide a wide range of scaling correction for direct readout in terms of units being measured.

The Gemini 2000 20 mA Current Loop Option provides the capability of two-way communications between the Gemini 2000 and a variety of equipment, such as a printer, remote terminal, or host computer. The Baud rate can be set to 300, 600, 1200 or 2400 baud. The format for transmitted and received data is 1 start bit, 7 data bits, 1 parity bit (*odd*), and 1 stop bit. When utilizing an external power supply (30 VDC max), up to 16 units can be installed in the loop, each with an individual address. When utilizing the Gemini's 20 mA current source, up to seven units can be installed in a loop. The Count value, Scale Factor, and Preset values can be interrogated. The Scale factor and Presets can be changed by sending the proper command codes and numerical Data. Other functions such as resetting the count, and a

combined transmit count and reset can also be performed. Various "Print Options" can be selected to automatically interrogate the Count Value, Preset, or Scale Factor by activating the "Print Request" terminal when a printer is being used, or by sending a "transmit per Print Options" (P) command. All command codes and numerical data are sent in ASCII.

The construction of the Gemini 1000/2000 features a zinc die-cast bezel offering maximum durability with a high quality appearance. The sealed front panel meets NEMA 4/IP65 specifications, for wash-down and/or dust when properly installed. Electrical connections are made via pluggable terminal strips at the rear of the unit. Clamp-type pressure plate terminals accept stripped #14 AWG wire without lugs.

SPECIFICATIONS

1. **DISPLAY:** 6-digit 0.56" (14.2 mm) High LED display.
2. **POWER REQUIREMENTS:**
AC Power: Switch selectable 115/230 VAC (±10%), 50/60 Hz, 20 VA
DC Power: 11 to 14 VDC @ 0.7 A max.
3. **SENSOR POWER:** +12 VDC (±25%) @ 100 mA max.
4. **MEMORY:** Non-volatile E²PROM memory retains all programming information and count value when power is removed or interrupted.
5. **INPUTS A & B:** Switch selectable to accept count pulses from a variety of sources including switch contacts, outputs from CMOS or TTL circuits, and all standard RLC sensors.
Current Sourcing - Unit provides 3.9 KΩ pull-down load for sensors with current sourcing outputs. Max. input voltage = 28 VDC @ 7 mA.
Current Sinking - Unit provides 7.8 KΩ pull-up load for sensors with current sinking outputs. Max. sensor current = 1.6 mA.
Debounce - Damping capacitor provided for switch contact debounce. Limits count speed to 100 Hz max. with 50% duty cycle.

DIMENSIONS In inches (mm)

Note: Recommended minimum clearance (behind the panel) for mounting clip installation is 6.8" (173 mm) W.

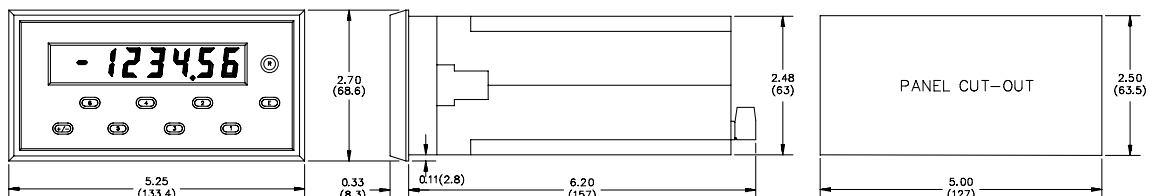

PROGRAMMABLE FUNCTIONS

UNIT PERSONALITY

Functions as a Counter and Rate Indicator.

PRESET(S)

Range 0 to ±999999

SCALE FACTORS

5-digit input scaling, Range 0.0000 to ±5.9999.

SCALE MULTIPLIER

Multiplies the contents of the 9-digit internal counter by a factor of 1, 0.1, 0.01, or 0.001 to view the desired number of significant digits on the 6-digit display.

COUNTING MODES

Count with Inhibit
Count with Up/Down Control
2-Input Anti-Coincidence Add
2-Input Anti-Coincidence Add/Subtract
Quadrature
Quadrature X4

RESET ACTION

Reset-to-Zero: Output activates when count equals the preset value. Counter returns to zero when reset.

Reset-to-Preset: Output activates when count equals zero. Counter returns to preset value when reset.

RESET MODES

Manual Reset
Automatic Reset at Preset
Automatic Reset after Output Time Delay

Note: Manual reset via front panel pushbutton or remote "RST." terminal can be programmed for momentary or maintained action. Front panel reset may be disabled by a switch at the rear of the unit.

SELF-TEST

Performs a complete check on the display and output circuitry along with a functional check on the CPU. Self-test is non-destructive and may be performed during a process without losing counts.

FREQUENCY DOUBLING

Registers counts on both edges of input signal.

DECIMAL POINT & LEADING ZERO BLANKING

Decimal point programmable to desired location. Leading zero blanking, when selected, begins with second digit to the left of the decimal point.

RIGHT-HAND DUMMY ZEROS

Up to three non-functional zeros may be placed on the least significant end of the display.

OUTPUT TERMINATION MODES

Terminate at "other" Output Start (*Gemini 2000 only*)

Terminate at "other" Output End (*Gemini 2000 only*)

Terminate at Manual Reset

Terminate at Manual Reset End

Terminate after Time Delay

Boundary

For positive preset value: Output terminates when Display is less than Preset.

For negative preset value: Output terminates when Display is greater than Preset (*i.e. more positive*).

Note: In any of the above modes, the unit may be programmed for "Reverse Phase" operation which complements the logic state of the output.

OUTPUT TIME DELAY

Programmable from 0.01 to 599.99 seconds. Accurate to ±(0.01% + 10 msec.).

SAMPLE TIME MULTIPLIER

Multiplies the basic one-second data sampling time by 1, 2, 5, 10, 20, or 50. Accurate to ±0.01%.

FRONT PANEL LOCKOUT MODES

When the "Program Disable" control input is activated, the ability to change front panel programmed functions will be prevented as per the following modes:

Complete Front Panel Disable

Preset(s) Enabled Only

Scale Factor Enabled Only

Both Preset(s) and Scale Factor Enabled

Note: Reset may be enabled or disabled in any of the above modes.

SPECIFICATIONS (Cont'd)

Lo Bias - Input trigger levels $V_{IL} = 1.5$ V max., $V_{IH} = 3.75$ V.

Hi Bias - Input trigger levels $V_{IL} = 5.5$ V max., $V_{IH} = 7.5$ V.

Note: Bias levels given are ±10% @ 12 VDC. They vary proportionally with sensor supply voltage.

6. MAGNETIC PICKUP INPUT:

Sensitivity - 150 mV peak nominal

Hysteresis - 100 mV nominal

Input Impedance - 26.5 K Ω @ 60 Hz nominal

Maximum Input Voltage - ±50 V peak

7. MAXIMUM COUNT RATES:

Uni- or Bi-Directional Modes: 9 KHz; 8 KHz (X2)

2-Input Anti-Coincidence Modes: 5 KHz; 4 KHz (X2)

Quadrature Modes: 5 KHz; 4 KHz (X2 or X4)

Rate Indicator: 10 KHz; 8 KHz (X2)

8. CONTROL INPUTS:

Reset - Active Low ($V_{IL} = 1.5$ V max.) internally pulled up to +12 VDC ($I_{SNK} = 3$ mA), response time = 10 msec (*typical*).

Program Disable - Active Low ($V_{IL} = 1.5$ V max.), internally pulled up to +5 VDC ($I_{SNK} = 1$ mA).

Print Request - (*GEM2 only*) Active Low ($V_{IL} = 1.5$ V max.) internally pulled up to +5 VDC ($I_{SNK} = 1$ mA).

9. SERIAL COMMUNICATIONS (Optional, Gemini 2000 only):

Type - Bi-directional 20 mA current loop, 20 mA source provided. (*Powers up to seven units in a loop with internal current source.*)

Baud Rate - Programmable 300 to 2400.

Maximum Address - 16 units (0 to 15). (*Actual number in a single loop is limited by serial hardware specifications.*)

Data Format - 10 bit frame, Odd parity (*one start bit, 7 data bits, one odd parity bit, and one stop bit.*)

Serial Hardware Specifications -

SO - Output Transistor Rating: $V_{MAX} = 30$ VDC, $V_{SAT} = 1 V_{MAX}$ @ 20 mA. (*Can address 16 units in a loop*)

SI - Input Diode Rating: $V_F = 1.25 V_{TYP}$; $1.5 V_{MAX}$

Note: The compliance voltage rating of the source must be greater than the sum of the voltage drops around the loop.

10. OUTPUT(S):

Solid-State - Current sinking NPN Open Collector Transistor(s). $I_{SNK} = 100$ mA max. $V_{OH} = 30$ VDC max. (*Internal Zener Diode Protected*). $V_{OL} = 1$ VDC max @ 100 mA

Relay(s) - Mounted on a field-replaceable P.C. board. Form C contacts rated 5 amps @ 120/240 VAC, 28 VDC (*resistive load*), 1/8 H.P. @ 120 VAC (*inductive load*). The operate time is 5 msec nominal and the release time is 3 msec nominal.

Relay Life Expectancy - 100,000 cycles at max. rating. (*As load level decreases, life expectancy increases.*)

Programmable Timed Outputs(s) - The timed output(s) can be set from 0.01 to 599.99 seconds, ±(0.01% + 10 msec).

11. CERTIFICATIONS AND COMPLIANCES:

SAFETY

IEC 1010-1, EN 61010-1: Safety requirements for electrical equipment for measurement, control, and laboratory use, Part 1.

IP65 Enclosure rating (Face only), IEC 529

Type 4 Enclosure rating (Face only), UL50

ELECTROMAGNETIC COMPATIBILITY:

Immunity to EN 50082-2

Electrostatic discharge EN 61000-4-2 Level 2; 4 Kv contact¹
Level 3; 8 Kv air

Electromagnetic RF fields EN 61000-4-3 Level 3; 10 V/m
80 MHz - 1 GHz

Fast transients (burst) EN 61000-4-4 Level 4; 2 Kv I/O
2 Kv power²

RF conducted interference EN 61000-4-6 Level 3; 10 V/rms
150 KHz - 80 MHz

Power frequency magnetic fields EN 61000-4-8 Level 4; 30 A/m

Emissions to EN 50081-2

RF interference EN 55011 Enclosure class A
Power mains class A

Notes:

1. Metal bezel of unit connected with ground lead from rear bezel screw to metal mounting panel.

2. When the unit is DC powered, a power line filter (RLC# LFIL0000 or equivalent) was installed, so as not to impair the function of the unit.

Refer to the EMC Installation Guidelines section of the manual for additional information.

12. ENVIRONMENTAL CONDITIONS:

- Operating Temperature:** 0 to 50°C
- Storage Temperature:** -40 to 80°C
- Operating and Storage Humidity:** 85% max. relative humidity (non-condensing) from 0 to 50°C.
- Altitude:** Up to 2000 meters

13. CONSTRUCTION:

Metal die-cast bezel, plastic case. This unit is rated for NEMA 4/IP65 indoor use. Installation Category II, Pollution Degree 2

14. WEIGHT: 2.1 lbs. (0.9 kg)

PROGRAMMING

The Gemini 1000/2000 input circuit set-up is programmed using DIP switches on the rear of the unit. All other functions are programmed through the front panel pushbuttons.

To program or interrogate a function, the user first enters a two-digit function code. The unit will then display that function code along with a single-digit representing the present mode of operation. Programming changes are made by changing the single-digit mode identifier.

EXAMPLE: The function code representing the "Unit Personality" is 41. The mode identifiers for this function are:

Counter (1) and Rate Indicator (2).

To interrogate the Unit Personality, Press "41":
Unit displays function code along with mode identifier (*Rate Indicator*).

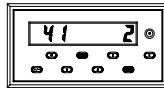

To change the Unit Personality to Counter mode, Press "1":
Unit displays the new mode identifier (*Counter*).

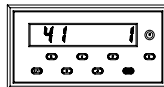

Press "E":

Unit enters new mode and returns display to the present count value.

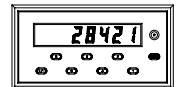

The most commonly used functions, Preset(s) and Scale Factor, are initialized through single front panel pushbuttons rather than a two-digit function code. Pressing the "1" or "3" pushbuttons will immediately display the current Preset or Scale Factor value for the selected display. To change any digit, the user presses the pushbutton directly below that particular digit, which is then scrolled until the desired value is obtained. Each digit is changed, if necessary, in the same manner until the complete Preset or Scale Factor value is registered on the display. Pressing the "E" pushbutton completes the entry sequence.

To interrogate the Preset value, Press "1":
Unit displays current Preset value.

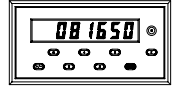

To change the Preset value:
Any digit may be changed by pressing the pushbutton directly below it. Release the pushbutton when the digit reaches the desired value.

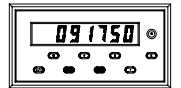

Press "E":

Unit enters new Preset value and returns display to the present count.

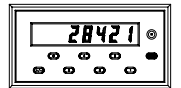

TYPICAL COUNTER APPLICATIONS

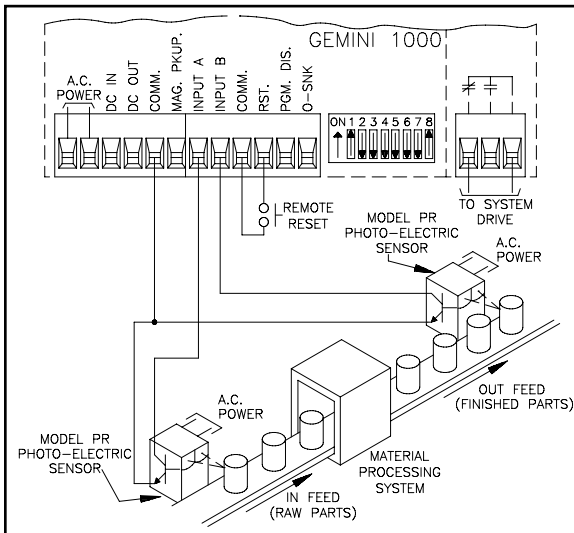

"IN PROCESS" MONITORING SYSTEM

Some applications require continuous monitoring of items "in-process". In this example, a material processing system is equipped with an in-feed photo-electric scanner to count raw parts going into the system, and an out-feed scanner to count finished parts leaving the machine. The number of parts between the in-feed and out-feed is displayed by the GEMINI 1000 operating in the Anti-Coincidence Add/Subtract mode. In this mode, counts applied to INPUT A are added while counts applied to INPUT B are subtracted.

Before start-up, the system is completely empty of parts and the counter is reset to zero. When the operation begins, raw parts move through the in-feed scanner field of view with each part generating an "up" count. After processing, finished parts appearing at the out-feed scanner generate "down" counts so the counter continuously displays the number of "in-process" parts.

The GEMINI 1000 preset value is set to the maximum system capacity and the output is used to control power to the system drive. Therefore, if a jam-up occurs within the system and the maximum capacity is reached, the counter output will shut down the system drive until the problem can be corrected.

Conversely, the counter could be used in the Reset-to-Preset mode which delivers an output at zero. If the supply of raw parts is interrupted, the system will eventually empty and the counter will reach zero. At this point, the counter output will shut down the system drive until the supply of raw parts is replenished.

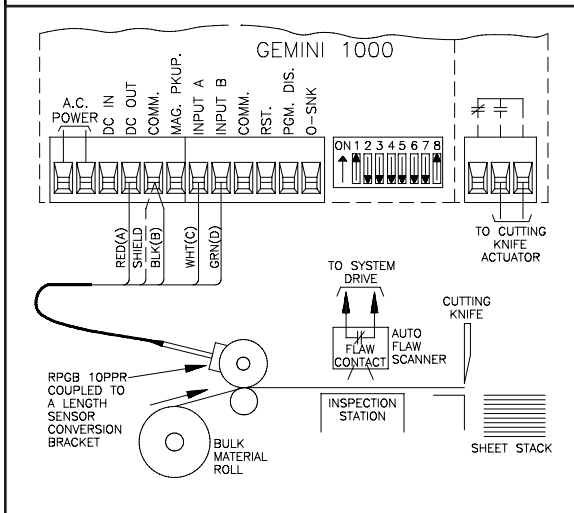

"CUT-TO-LENGTH" WITH FLAW DETECTION

In this application, sheets of material are to be cut to length as per customer order with any flaws being corrected by the vendor. Sales are both domestic and foreign and require lengths to be measured in either yards or meters.

A rotary pulse generator (RPG) with a 10 pulse/revolution (PPR) quadrature output is coupled to a length sensor conversion bracket with a 4/10 yard wheel. The GEMINI 1000 is set up in the Quadrature x4 mode which effectively increases the RPG output to 40 PPR. With the 4/10 yard wheel, the information rate becomes 100 pulses/yard and allows the material to be cut to the nearest 1/100 yard. The counter display is programmed for two decimal places to provide a readout in 1/100 yard increments.

The Preset value on the GEMINI 1000 is set to the desired length of material and the output is used to control power to the cutting knife. The counter is programmed to automatically reset to zero at the preset value which allows the process to run continuously without losing counts. If a flaw is detected, a contact in the flaw detector is used to shut down power to the system drive allowing the material to be "backed-up" to the point at which the flaw occurred. As the material is rewound, the counter will count "down" to maintain a readout of the total length of material "in-process". For metric orders, the scale factor on the GEMINI 1000 is set to 0.9144 which provides the conversion from yards to meters (1 yard = 0.9144 meters). Otherwise, all equipment and settings remain as above.

TYPICAL COUNTER APPLICATIONS (Cont'd)

TYPICAL RATE INDICATOR APPLICATION

COIL WINDING MACHINE CONTROL W/REMOTE PRINTING

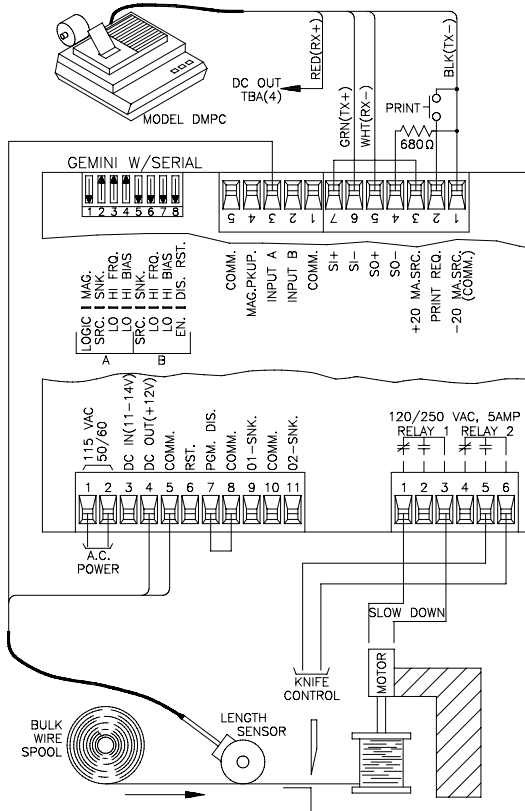

This application depicts a GEMINI 2000 controlling a coil winding machine. A length sensor provides output units in feet. Output 1 is used as the slow-down for the drive motor and Output 2 is used for the cut off knife control. A printer is used to record the length of each coil that is wound. Preset 1 is set to the slow down length and Preset 2 is set to the desired length of the coil.

RATE INDICATION WITH SPEED LIMITING

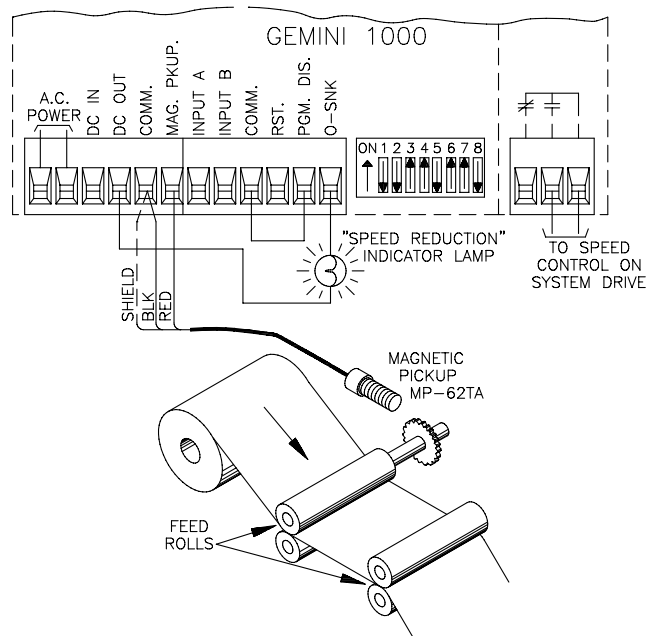

In this application, a GEMINI 1000 is used to indicate the speed of a printing press operation in feet/minute, while limiting the maximum speed to a desirable level.

A magnetic pickup is used to sense a gear coupled to a feed roll on the system drive. The scale factor on the GEMINI 1000 is set to provide a direct readout in feet/minute with a one-second sample time.

The maximum allowable speed of the operation is entered as the preset value on the rate indicator. The output termination is programmed for the "boundary" mode in which the output remains "OFF" as long as the speed of the operation stays below the preset level. If the operational speed equals or exceeds the maximum allowable limit, the output will turn "ON" and remain "ON" until the speed is reduced below the preset value.

The output of the GEMINI 1000 is tied to the speed control circuitry of the system drive and triggers the necessary speed reduction if the maximum allowable rate is exceeded. The jumper between the "Program Disable" and "Common" terminals is used to prevent any accidental or unauthorized programming changes. Connecting the jumper after the unit set-up is complete will allow full interrogation of front panel functions, although any function alteration will be inhibited.

ORDERING INFORMATION

MODEL NO.	DESCRIPTION	W/20 mA CURRENT LOOP	PART NUMBERS FOR AVAILABLE SUPPLY VOLTAGES	
			115/230 VAC	
GEM1	Gemini 1000	No	GEM10060	
GEM2	Gemini 2000	No	GEM20060	
		Yes	GEM20160	
-	Gemini 1000 Relay Board	N/A	RLYBD000	
-	Gemini 2000 Relay Board	N/A	RLYBD002	

For more information on Pricing, Enclosures, & Panel Mount Kits, refer to the RLC Catalog or contact your local RLC distributor.

GEMINI 1000 PROGRAMMING CHART

FEATURE & MODE SELECTION (See Programming Procedure)

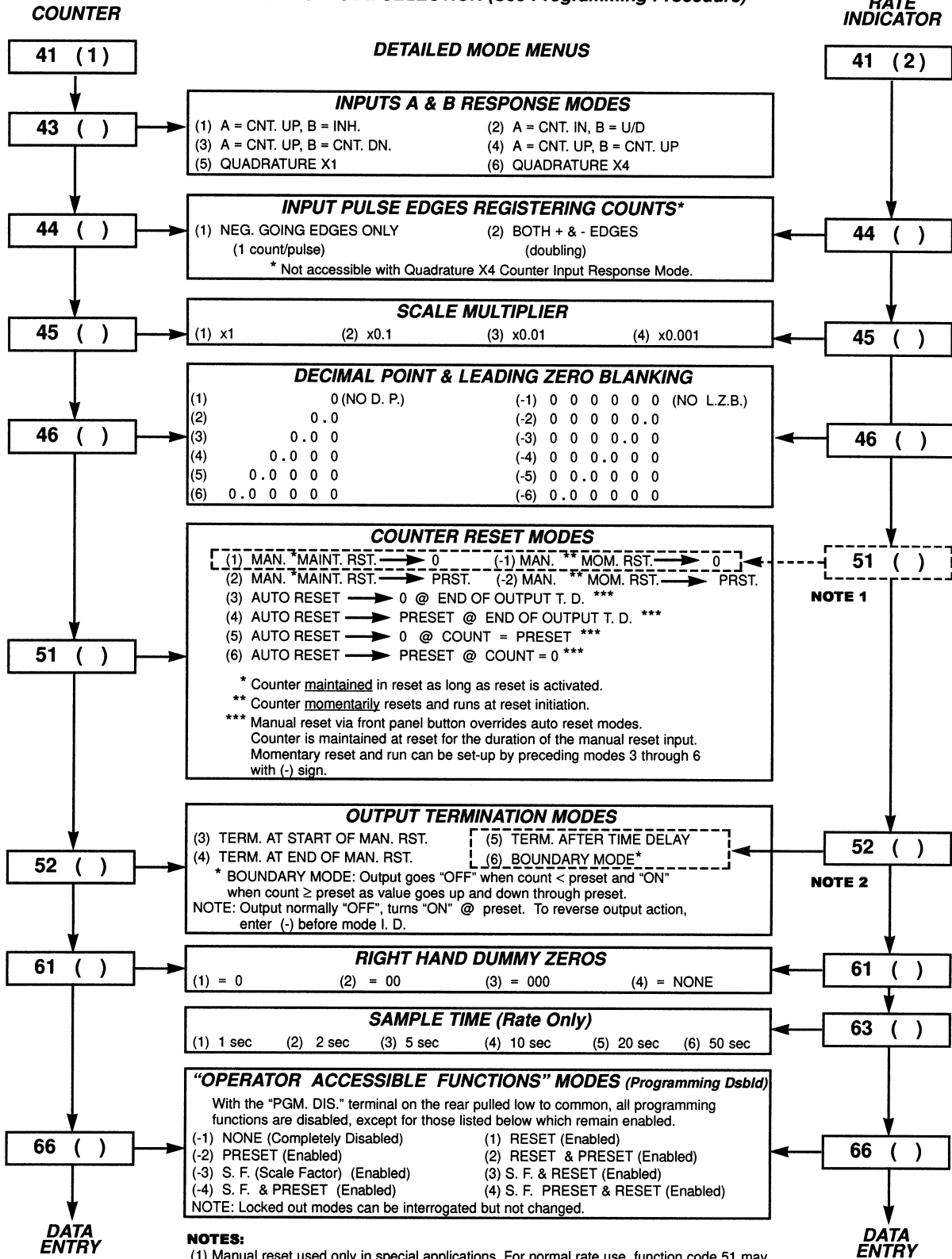

NOTES:

- (1) Manual reset used only in special applications. For normal rate use, function code 51 may be ignored, and switch S8 on rear should be set on "DISABLE" to deactivate reset button.
- (2) Rate applications normally use only (5) or (6).

GEMINI 1000 PROGRAMMING

SOME NOTES & HINTS ON PROGRAMMING THE GEMINI 1000

1. Be systematic about programming! Plan out the exact features & functions you need for your application. Write out the code entries you need from start to finish, and then enter the codes completely. Don't start in the middle of the program codes & make arbitrary entries to "see what it will do." This is a sure way to create confusing results. Finally, after you are done, record your program & file it where you can find it later if you want to make changes. You can use this card to write in your codes in the program ladder on the reverse side, together with any fixed data entries, for convenient future reference.

2. Watch out for conflicting modes! The programs in the GEMINI 1000 have been written to prevent illegal code entry. However, to provide optimum flexibility, some reliance must be placed on the programmer to avoid conflicting codes. For example, when set-up as a counter with any of the automatic reset modes (51 3, 4, 5 or 6), the entry of a manual output termination

code (52 3) or (52 4) results in a situation where the counter will cycle but the output simply latches on & stays on until a manual reset occurs.

3. The GEMINI 1000 can be interrogated at any time to see what modes & data entries have been made. Such interrogation can be made during a counting cycle or a sample time run without interrupting the normal counting process. In the lockout mode, all functions can also be interrogated, but those functions locked out cannot be changed. Making changes in program modes or data during a run is not recommended since mid-cycle changes can result in unanticipated outputs for that particular cycle.

PROGRAMMING PROCEDURE FOR FUNCTION & MODE SELECTION ☆

(Applies To Programming Chart)

To enter a programmable function or mode, enter the function selector code desired and then select the particular mode identifier required.

For example, to set up a decimal point to display a reading in 1/100ths with leading zero blanking, function selector code #46 must be entered. (See codes on reverse side.)

Press button #4, then button #6. The display will temporarily interrupt its normal readout (without interfering with the normal operation of the unit) and will display the entered code on the L.H. side.

[46] (DISPLAY READOUT)

Next enter the mode identifier (button #3) that defines the decimal point location & LZB condition. This code is displayed on the right.

[46 3] (DISPLAY READOUT)

Now enter this new selection by pressing the "E" button.

PROGRAMMING PROCEDURE FOR DATA ENTRY

(Applies To Both Counter [41 1] Mode & Rate Indicator [41 2] Mode)

In data entry, the front panel pushbuttons are identified by two different sets of references and will cause two different reactions in the course of making a data entry.

In the first phase of a data entry cycle, the particular data entry mode is called up by pushing the buttons identified by their panel markings. (i.e. Buttons "5", "3", or "1"). Once the data entry mode has been entered, the existing data appears on the display and the buttons below the display reference themselves to the digits directly above each button. The data can then be changed a digit at a time by depressing the button directly below the digits to be changed. After the new data value is obtained, the "E" button is depressed to enter the new value.

[53] OUTPUT TIME DELAY SETTING ☆

Entering Code "53" will call up the time delay setting in seconds & hundredths. The T.D. can now be set to the new value by incrementing each digit

with the button underneath that digit. Press the "E" button to enter the new T.D. value. (Max. T.D. = 599.99 sec.)

[3] SCALE FACTOR

One stroke of the "3" button calls up the existing scale factor. (The scale factor is the multiplier used to convert the actual count pulses coming into the unit & stored in the counter into the direct readout display). The value can now be changed by incrementing each digit with the button below it. Depressing the "E" key enters the new S.F. S.F. can be set at any value from -5.9999 to +5.9999.

[1] PRESET

One stroke of the "1" button calls up the preset value which can then be changed by incrementing each digit with the button below it. Depress the "E" button to enter the new Preset.

☆Program before connecting "PGM. DIS." to "COMMON".

SELF TEST ROUTINE 6, +/-

Depressing "6" & then "+/-" starts the self test routine by lighting all decimal points, then all 9's, all 8's, all 7's etc., down to all zeros. Then it displays alternate 1's & 2's, etc., until alternate 8's & 9's are displayed. At this time, the output can be manually activated for testing by pressing the "1" button. (Output test is disabled when "PGM. DIS." terminal

is pulled to "COMMON".) Pressing the "E/CNT" button will exit the Test Mode at any time, or automatic exit will occur six (6) seconds after the Test Mode is completed. Test Mode can be run at any time and will not interfere with the normal operation of the Gemini 1000 during a run.

GEMINI 2000 PROGRAMMING CHART

FEATURE & MODE SELECTION (See Programming Procedure)

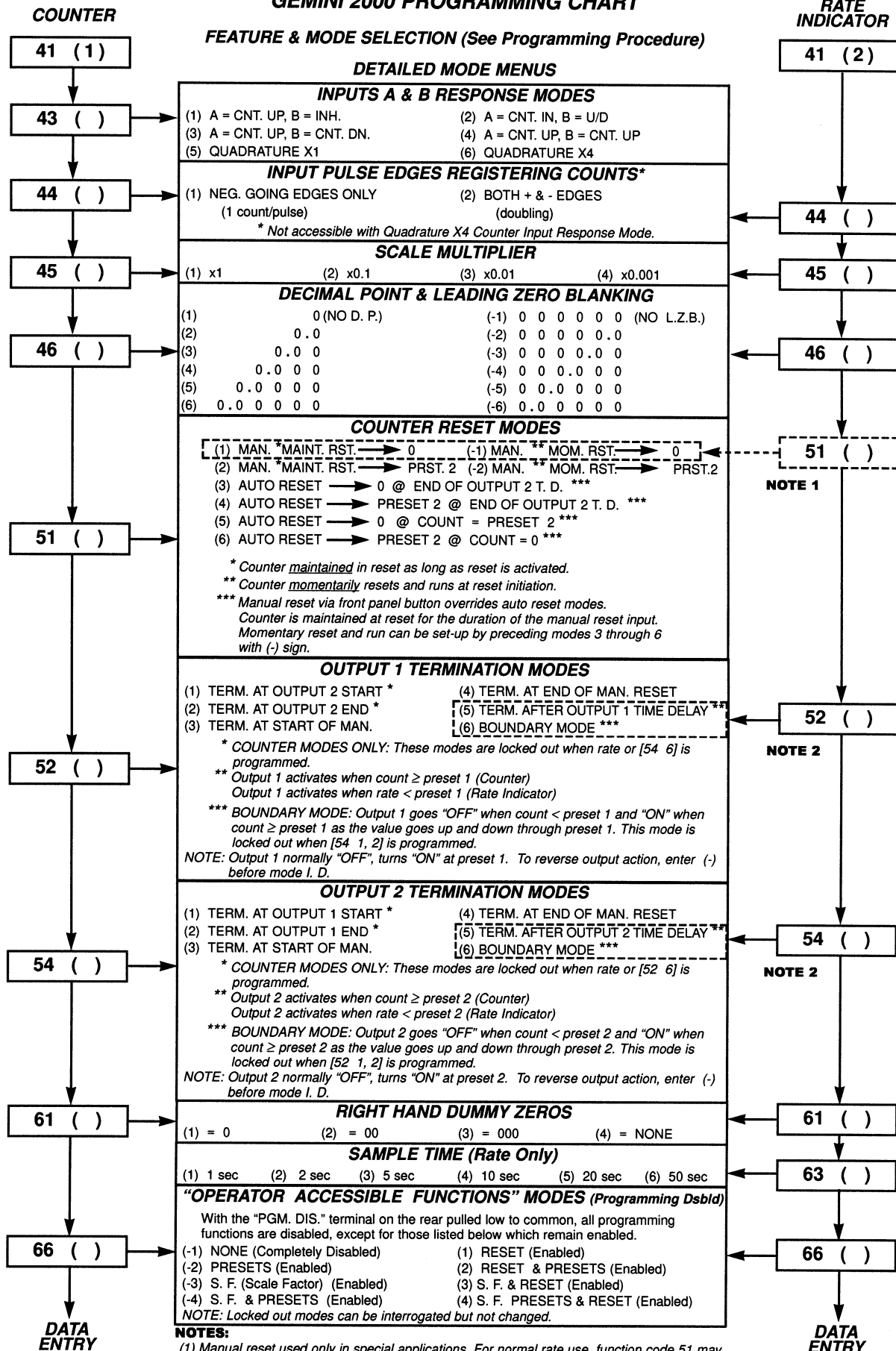

NOTES:

- (1) Manual reset used only in special applications. For normal rate use, function code 51 may be ignored, and switch S8 on rear should be set on "DISABLE" to deactivate reset button.
- (2) Rate applications normally use only (5) or (6).

GEMINI 2000 PROGRAMMING

SOME NOTES & HINTS ON PROGRAMMING THE GEMINI 2000

1. Be systematic about programming! Plan out the exact features & functions you need for your application. Write out the code entries you need from start to finish, and then enter the codes completely. Don't start in the middle of the program codes & make arbitrary entries to "see what it will do." This is a sure way to create confusing results. Finally, after you are done, record your program & file it where you can find it later if you want to make changes. You can use this card to write in your codes in the program ladder on the reverse side, together with any fixed data entries, for convenient future reference.

2. Watch out for conflicting modes! The programs in the GEMINI 2000 have been written to prevent illegal code entry. However, to provide optimum flexibility, some reliance must be placed on the programmer to avoid conflicting codes. For example, when set-up as a counter with any of the automatic reset modes (51

3, 4, 5 or 6), the entry of a manual output termination code (52 3) or (52 4) results in a situation where the counter will cycle but the output simply latches on & stays on until a manual reset occurs.

3. The GEMINI 2000 can be interrogated at any time to see what modes & data entries have been made. Such interrogation can be made during a counting cycle or a sample time run without interrupting the normal counting process. In the lockout mode, all functions can also be interrogated, but those functions locked out cannot be changed. Making changes in program modes or data during a run is not recommended since mid-cycle changes can result in unanticipated outputs for that particular cycle.

PROGRAMMING PROCEDURE FOR FUNCTION & MODE SELECTION ☆

(Applies To Programming Chart)

To enter a programmable function or mode, enter the function selector code desired and then select the particular mode identifier required.

For example, to set up a decimal point to display a reading in 1/100ths with leading zero blanking, function selector code #46 must be entered. (See codes on reverse side.)

Press button #4, then button #6. The display will temporarily interrupt its normal readout (without interfering with the normal operation of the unit) and will display the entered code on the L.H. side.

[46] (DISPLAY READOUT)

Next, enter the mode identifier (button #3) that defines the decimal point location & LZB condition. This code is displayed on the right.

[46 3] (DISPLAY READOUT)

Now enter this new selection by pressing the "E" button.

PROGRAMMING PROCEDURE FOR DATA ENTRY

(Applies To Both Counter [41 1] Mode & Rate Indicator [41 2] Mode)

In data entry, the front panel pushbuttons are identified by two different sets of references and will cause two different reactions in the course of making a data entry.

In the first phase of a data entry cycle, the particular data entry mode is called up by pushing the buttons identified by their panel markings. (i.e. Buttons "5", "3", or "1"). Once the data entry mode has been entered, the existing data appears on the display and the buttons below the display reference themselves to the digits directly above each button. The data can then be changed a digit at a time by depressing the button directly below the digits to be changed. After the new data value is obtained, the "E" button is depressed to enter the new value.

[53,55] OUTPUT TIME DELAY SETTING ☆

Entering Code "53" or "55" will call up the output 1 or output 2 time delay setting in seconds & hundredths. The T.D. can now be set to the new

value by incrementing each digit with the button underneath that digit. Press the "E" button to enter the new T.D. value. (Max. T.D. = 599.99 sec.)

[3] SCALE FACTOR

One stroke of the "3." button calls up the existing scale factor. (The scale factor is the multiplier used to convert the actual count pulses coming into the unit & stored in the counter into the direct readout display). The value can now be changed by incrementing each digit with the button below it. Depressing the "E" key enters the new S.F. S.F. can be set at any value from -5.9999 to +5.9999.

[1,2] PRESETS

One stroke of the "1" or "2" button calls up the preset value which can then be changed by incrementing each digit with the button below it. Depress the "E" button to enter the new Preset.

☆ Program before connecting "PGM. DIS." to "COMMON".

SELF TEST ROUTINE 6, +/-

Depressing "6" & then "+/-" starts the self test routine by lighting all decimal points, then all 9's, all 8's, all 7's etc., down to all zeros. Then it displays alternate 1's & 2's, etc., until alternate 8's & 9's are displayed. At this time, the outputs can be manually activated for testing by pressing the "1" or "2" button. (Output test is disable when "PGM. DIS."

terminal is pulled to "COMMON".) An automatic exit will occur six (6) seconds after the Test Mode is completed. Test Mode can be run at any time and will not interfere with the normal operation of the Gemini 2000 during a run.